

S.C.P. MOUNTING

Natural frequency : (1)
9 to 15 Hz

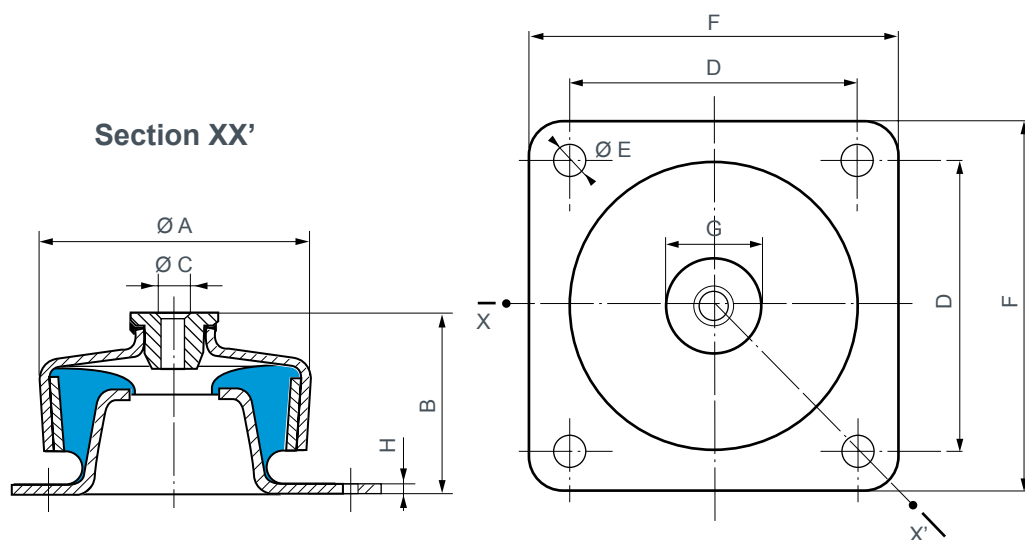

DIMENSIONS

Reference	Ø A (mm)	B (mm)	Ø C (mm)	D (mm)	Ø E (mm)	F (mm)	G (mm)	H (mm)
530120	74	53	M10	72	9	90	32	3
530220	92	63	M12	90	11	114	36	3
530420	124	94	M16	114	13	144	60	4

OPERATING CHARACTERISTICS

Reference	Hardness 45		Hardness 60		Hardness 75		Weight (g)
	Load (daN)	Deflect. (mm)	Load (daN)	Deflect. (mm)	Load (daN)	Deflect. (mm)	
530120	70	3	120	2,5	175	2	580
530220	140	4	200	3	300	2,5	1 000
530420	300	5	500	5	800	4	2 550

See current price list for availability of items.

1) the indicated natural frequency, are valid for the maxi loads of the ranges of use quoted in the paragraph : TECHNICAL CHARACTERISTICS.